

Introduction

Levolux Curtains and Tracks combine to give the ideal solution to numerous problems from room darkening to privacy screening. Suitable for use in many applications, such as conference and leisure facilities, hotels, hospitals, stage and cinema, Levolux provides a wide range of curtains customised to meet the needs of architects and designers. In fact, Levolux curtains complement any room, whatever its function.

Features & Benefits

Aesthetically pleasing - With a limitless choice of finishes, fabrics, styles and linings, all specifications can be met with the minimum of fuss and the optimum performance and aesthetic design.

Finishing touches - All types of pelmets, drapes, swags and tails are available together with a selection of tiebacks.

Flexibility - All types of curtains can be supplied with headings ranging from machine gathered to hand sewn pinch pleats to suit fabric types and applications.

Silent, smooth and reliable - Curtain tracks are designed for maximum efficiency even when curved and are ideal for bays.

The Range

The **Levolux Curtain range** incorporates all curtain types and finishes, utilising an unlimited range of quality fabrics, linings, tracks and accessories.

With such flexibility Levolux can meet the specific needs of even the most demanding and stringent interior designer.

Levolux Easi-Hook® Cubicle Curtains are ideal in all applications where curtaining is a practical answer for variable, flexible partitioning and privacy. They are particularly popular in hospitals and nursing homes, providing easy access, adequate privacy and quick and simple hanging.

The exclusive Levolux system is fitted with pre-set hooking positions, thus eliminating the need for a tape heading, so that the curtains are provided with even support and easy travel on the tracks.

Materials and Accessories

Levolux curtains are designed to produce a high performance product with an aesthetically pleasing finish.

Fabrics - A wide range of plain and patterned fabrics are available in varying widths - usually 122cm or 137cm.

Sheers - An extensive range of lightweight, translucent or open weave fabrics can be chosen for all uses from privacy screening to bomb blast protection.

Linings - To fulfil the many functions that curtains need to provide, various linings (all flame retardant) are available - sateen cotton for general curtaining through to opaque linings where a high degree of dim-out is required. Acoustic protection can be achieved with interlinings for audio visual conference facilities.

Headings - Pinch pleat, pencil pleat and standard gathered headings are normally used. Other more specialist headings, such as goblet, are available.

Pelmets - All types of hard and soft pelmets, including swags and tails, valances, and shaped pelmets stiffened with buckram are available.

Tiebacks - A selection of tiebacks, either stiffened or soft traditional crescent-shaped, piped or self-piped, complete with brass tieback holders can be offered.

Controls and tracks - Manual and electrically operated tracks are available for all applications - from simple unlined curtains to motorised stage installations, together with many control options. Many tracks have the option of wall or ceiling mounting with a variety of fixing methods for wood, concrete, plasterboard or brick substrates as well as suspended ceilings. The aluminium tracks are available in a variety of colours and are also available satin anodised.

3 Year Warranty

All Levolux systems are made of a high grade material to exacting specifications. This enables us to offer a guarantee providing free of charge replacement parts should any system prove defective within 3 years of installation. This guarantee is conditional on manufacturer's recommended fitting and operating instructions having been followed.



Heading types

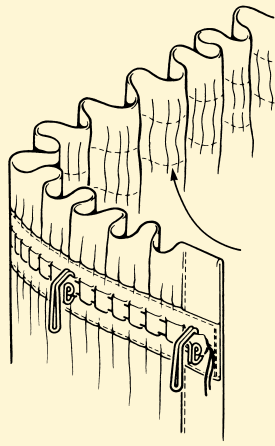

Standard gathered heading.

- Random pleats.
- 50% fullness minimum.
- Machine sewn.
- Uses standard heading tape and hooks.
- One hooking position.

Particularly suitable for sheer (open weave) curtains.

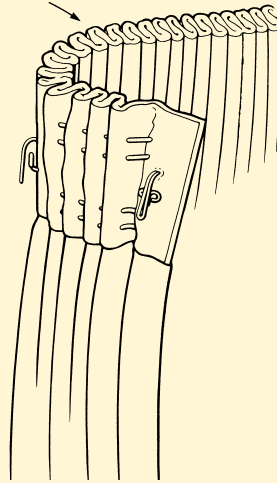

Pencil pleat heading.

- Regular pleats.
- 100% fullness recommended.
- Machine sewn.
- Uses special heading tape and standard hooks.
- 3 hooking position.

Triple pinch pleat heading.

- Regular 'sewn-in' pleat panels.
- 150% fullness recommended.
- Hand sewn.
- Specially stiffened heading and pin-hooks.
- Adjustable hook positions.

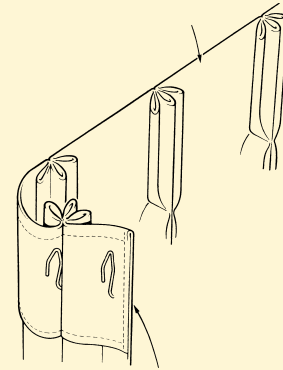

Ideal for heavier fabrics eg. Velour.

- 'Stacks' more neatly than Pencil heading.

Levolux Easi-Hook® Cubicle Curtains Exclusive Levolux Design

Triple thickness with 'sewn-in'
25% fullness as standard

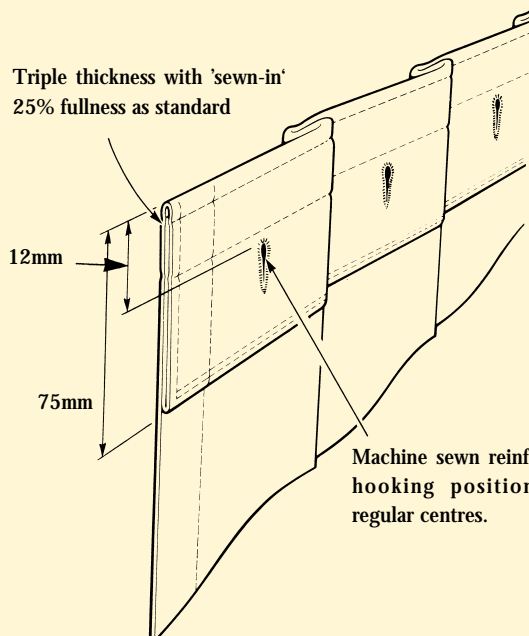

Machine sewn reinforced
hooking positions at
regular centres.

Benefits.

- Pre-set hook centres ensure consistent visual effect and smooth travel.
- Easy to hang, easy to take down.
- Modular panel widths give multi access to cubicle.
- Neater stacking.
- Simple to launder.
- Identification labels sewn in.
- Double 75mm bottom hems as standard.

N.B. Fullness is a measure of the fabric required for a particular heading to cover a window opening

i.e: 100% fullness would require 2 x the width of the fabric.

50% fullness would require 1.5 x the width of the fabric.

Soft Blinds

Austrian Blinds - Touch and close pencil pleat tape is sewn along the top of the blind to give 200-300% fullness. Loop or ring tape is sewn at 30-40cm intervals down the length of the blind. Cord is threaded through to the headrail and locking mechanism. The blind is attached directly to the headrail by means of the touch and close tape.

Roman Blinds - Two distinct Roman blind effects can be created. Using loop tape, soft, natural folds result. For a crisp modern look (hardfold), steel rods are inserted into tubular tapes that have been sewn horizontally at 30-40cm intervals. Rod rings are spaced as required. Cord is again threaded through to the headrail and locking mechanism.

The velcro heading is simply pressed onto the headrail. The effect here is a hard structured fold. By omitting alternate steel rods in the blind, a semi-hard fold is produced with clearly defined panels but soft folds.

Festoon Blinds - Normal ruffling tape is used to create the pleats, or box pleats may be sewn in. Depending on the type of fabric, 50-100% fullness across the top and two or three times the fullness in the drop are generally recommended. Pile section velcro is then sewn across the top of the blind. Ring tape with draw cord is sewn along the length of the blind to create the ruches (these can also be sewn in or formed by machine). Cord is threaded through to the headrail and locking mechanism. The blind is then simply pressed onto the velcro headrail.

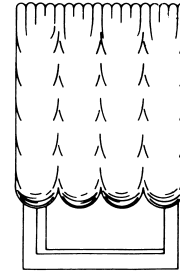

Austrian

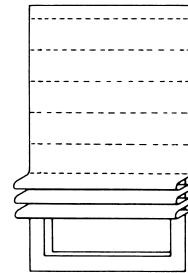

Roman

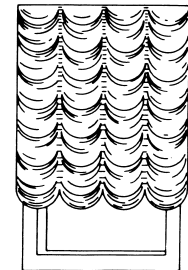

Festoon

Specification

Item:	Curtains	Type	#
To be Levolux Curtains/Easi-Hook® Cubicle Curtains to the following specification.		Length.....	#
Face fabric.....	#	Heading Type.....	#
Lined/ Unlined *		Pair/ Single *	
		Width	#
		Drop.....	#

Supplied and installed by an approved Levolux distributor. # Insert as applicable *Delete as applicable.

In line with the policy of continuous product development Levolux reserves the right to alter specifications without prior notice.

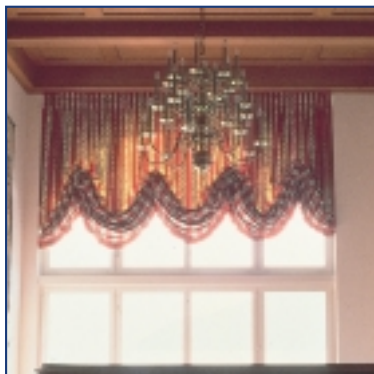

Austrian Blind



Roman Blind



Festoon Blind

For further information on Levolux sunscreening systems and effective ways to control light, heat and glare please contact:

Levolux Limited
 Forward Drive, Harrow,
 Middlesex HA3 8NT.
 United Kingdom
 Telephone: (+44) 020 8863 9111
 Facsimile: (+44) 020 8863 8760
 www.levolux.com
 info@levolux.com



Levolux A.T. Limited
 24 Eastville Close, Eastern Avenue,
 Gloucester GL4 3SJ
 United Kingdom
 Telephone: (+44) 01452 500007
 Facsimile: (+44) 01452 527496
 www.levolux.com
 info@levolux.com